

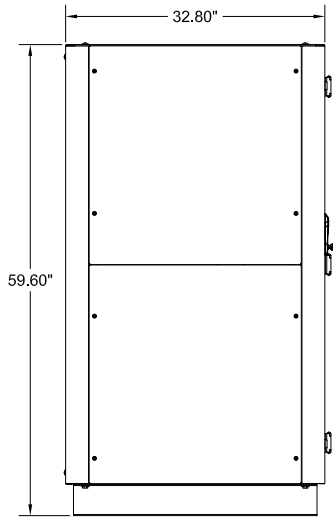

TOP VIEW

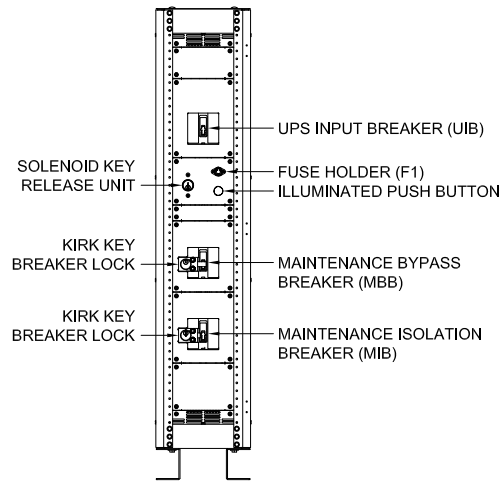

LEFT SIDE VIEW



FRONT VIEW  
(DOOR REMOVED)

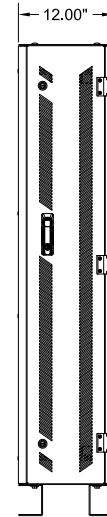

FRONT VIEW

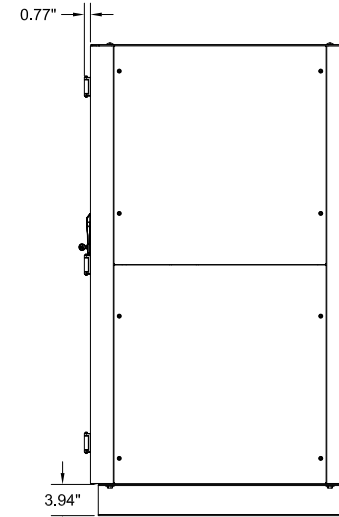

RIGHT SIDE VIEW

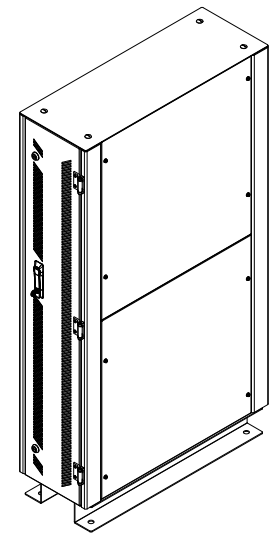

ISOMETRIC VIEW

- UPS INPUT BREAKER (UIB)
- FUSE HOLDER (F1)
- ILLUMINATED PUSH BUTTON
- MAINTENANCE BYPASS BREAKER (MBB)
- MAINTENANCE ISOLATION BREAKER (MIB)
- SOLENOID KEY RELEASE UNIT
- KIRK KEY BREAKER LOCK
- KIRK KEY BREAKER LOCK

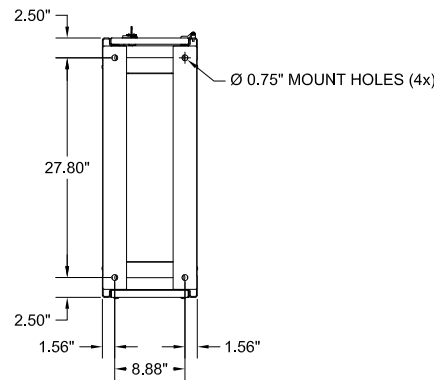

BOTTOM VIEW

NOTES:

- 1. APPROXIMATE WEIGHT: 275 LBS.
- 2. NEMA 1 TYPE ENCLOSURE.
- 3. THE CABINET IS CONSTRUCTED FROM GALVANIZED STEEL.
- 4. THE CABINET IS TO BE MOUNTED THROUGH THE 0.750" HOLES IN THE CABINET LEGS. THE LEGS ARE FORMED FROM 10 GAUGE STEEL.
- 5. FINISH IS POWDER COAT ON ALL EXTERNAL AND VISIBLE SURFACES, INTERIOR PANELS AND MOUNT BRACKETS ARE GALVANIZED FINISH.
- 6. CABINET LEGS ARE REVERSIBLE FOR EASY ACCESS TO CABINET FLOOR MOUNTING HARDWARE.

90851 SERIES MAINTENANCE BYPASS BREAKER CABINET			
30-40 KVA, 120V/208V, 3PH/4W 3 BREAKER WITH SKRU			
INTERLOCK CONFIGURATION 5			
DIMENSIONS ARE IN INCHES	INITIALS	DATE	THE INFORMATION CONTAINED IN THIS DRAWING IS THE SOLE PROPERTY OF C&C POWER, INC. ANY REPRODUCTION WITHOUT THE WRITTEN CONSENT OF C&C POWER, INC IS PROHIBITED.
TOLERANCES:	DRAWN CH	02/28/12	
DECIMALS: .XX ±.13	CHECKED CH	03/06/12	<b>C&amp;C POWER</b> <b>ENGINEERED POWER PRODUCTS</b> 949 N. Larch Ave. - Elmhurst, IL 60126 © 2012 C&C POWER, INC. ALL RIGHTS RESERVED
ANGLES: ±1°	MATERIAL: SEE NOTES SHEET 1		
.XXX ±.062	FINISH: SEE NOTES SHEET 1		
CAD GENERATED DRAWING DO NOT MANUALLY UPDATE			SHEET 1 OF 2
SCALE: A	REV: 1	SHEET 1 OF 2	

CIRCUIT BREAKER SUMMARY						
BREAKER TYPE	KVA	LOCATION	BREAKER MODEL	TRIP	AIC	WIRE RANGE
EATON SERIES C	30	MBB, MIB, UOB1, UOB2	EDB3125	125A	22K @ 240VAC	(1) 4 - 4/0
	40	MBB, MIB, UOB1, UOB2	EDB3150	150A	22K @ 240VAC	(1) 4 - 4/0

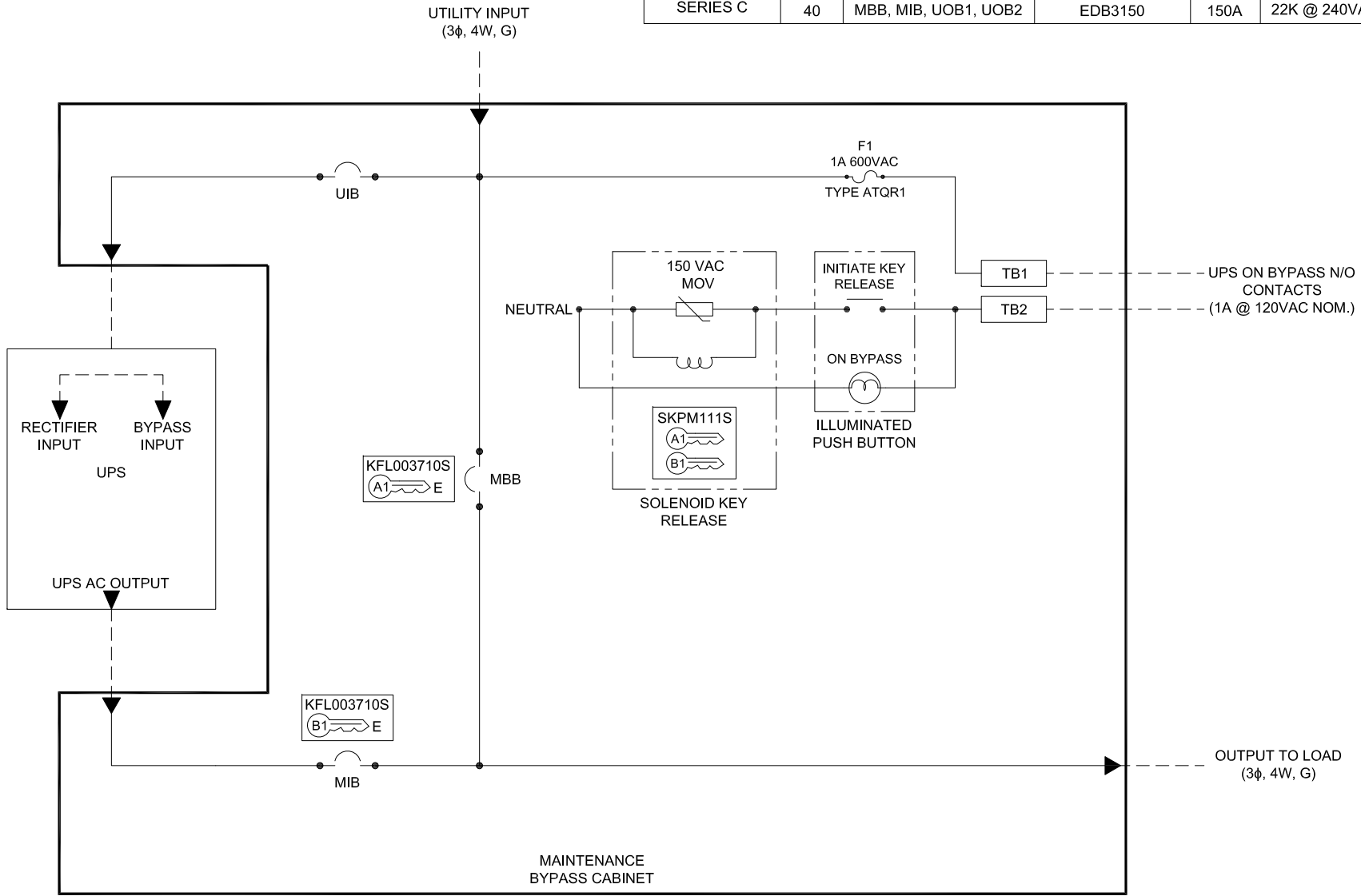

NOTES:

- "MBB" MAINTENANCE BYPASS BREAKER
- "MIB" MAINTENANCE ISOLATION BREAKER
- "UIB" UPS INPUT BREAKER
- GROUND LUG ACCEPTS (4) #6 - 350 MCM CABLES.
- NEUTRAL LUG ACCEPTS (4) #6 - 350 MCM CABLES.

KIRK KEY NOTES:

- THE "E" OR "W" IN THE INTERLOCK SYMBOL INDICATES THE POSITION OF THE INTERLOCK BOLT WHEN THE KEY IS REMOVABLE. "E" = EXTENDED AND "W" = WITHDRAWN.
- THE KEY OR KEYS IN THE INTERLOCK SYMBOL INDICATES THE KEY NUMBER THAT FUNCTIONS WITH THE INTERLOCK.

NOTE:  
DASHED LINES REPRESENT WIRING  
SUPPLIED BY OTHERS

90851 SERIES MAINTENANCE BYPASS BREAKER CABINET			
30-40 KVA, 120V/208V, 3PH/4W 3 BREAKER WITH SKRU			
INTERLOCK CONFIGURATION 5			
DIMENSIONS ARE IN INCHES		INITIALS	DATE
TOLERANCES:		DRAWN	03/02/12
DECIMALS: .XX ±.13	ANGLES: ±1°	CH	
.XXX ±.062		CHECKED	03/06/12
MATERIAL: SEE NOTES SHEET 1			
FINISH: SEE NOTES SHEET 1			
CAD GENERATED DRAWING DO NOT MANUALLY UPDATE			
SCALE: NTS	SIZE: A	REV: 1	SHEET 2 OF 2
THE INFORMATION CONTAINED IN THIS DRAWING IS THE SOLE PROPERTY OF C&C POWER, INC. ANY REPRODUCTION WITHOUT THE WRITTEN CONSENT OF C&C POWER, INC IS PROHIBITED.			<b>C&amp;C POWER</b> <b>ENGINEERED POWER PRODUCTS</b> 949 N. Larch Ave. - Elmhurst, IL 60126 © 2012 C&C POWER, INC. ALL RIGHTS RESERVED