



PowerVar

**ACE Series Rack-Mount
Uninterruptible
Power System**

1000 – 3000 VA

05145651A Mar-98

PowerVar
28457 N. Ballard Drive
Lake Forest, IL 60045
Tel: 847-816-8585
Fax: 847-816-8988

Class A Statement for FCC and ICES

For Users in the United States Only

Note: This equipment has been tested and found to comply with the limits for a Class A digital device pursuant to Part 15 of FCC Rules. These limits are designed to provide reasonable protection against harmful interference when this equipment is operated in a commercial environment. This equipment generates, uses, and can radiate radio frequency energy and, if not installed and used in accordance with the instruction manual, may cause harmful interference to radio communications. Operation of this equipment in a residential area is likely to cause harmful interference, in which case the user will be required to correct the interference at his/her own expense.

Changes or modifications not expressly approved by the party responsible for compliance could void the user's authority to operate the equipment.

For Users in Canada

This Class A Interference Causing Equipment meets all requirements of the Canadian Interference Causing Equipment Regulations ICES-003.

Cet appareil numérique de la classe A respecte toutes les exigences du Règlement sur le matériel brouilleur du Canada.

The following are examples of symbols used to alert you to important information:

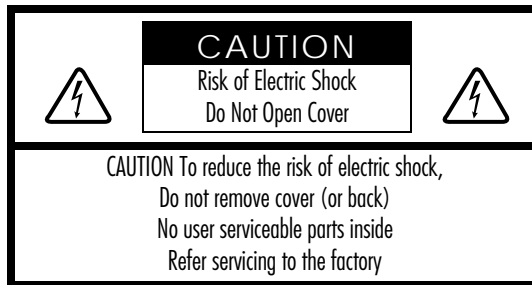

This symbol is intended to alert you to the presence of uninsulated "dangerous voltage" within the product's enclosure that may be of sufficient magnitude to constitute a risk of electric shock.



This symbol is intended to alert you to the presence of important operating and maintenance (servicing) instructions in the literature accompanying the appliance.



This symbol indicates that you should not discard the UPS or the UPS batteries in the trash. The UPS may contain sealed, lead-acid batteries. Batteries must be recycled.

How to Request a Declaration of Conformity

The EC Declaration of Conformity is available upon request for products with a CE mark. For copies of the EC Declaration of Conformity, contact:

MPL House

Prescott Road

Payle, Colnbrook

Berks SL3 0AE

UK

Phone: +44 1753 686200

Fax: +44 1753 686827

Contents

PREFACE

ACE SERIES RACK-MOUNT — ONE OF THE BEST!	1
How to Contact Us	2

SECTION 1

INSTALLATION	3
Inspecting Your Equipment	3
Safety Precautions	3
Mounting the UPS in a Rack	4
Installing the UPS	5

SECTION 2

OPERATION	9
Turning the UPS On	9
Turning the UPS Off	9
Silencing an Audible Alarm	9
Interpreting the LED Display	10
Putting the UPS in Standby Mode	11
Initiating the Self-Test	11

SECTION 3

CONFIGURATION	13
Why Change Factory Defaults?	13
Input Nominal Voltage (LEDs 1, 2, 3, and 10)	13
Extended Nominal Voltage Range (LED 4)	13
Other Settings	13
Reconfiguring Functions	14

SECTION 4

UPS CARE AND BATTERY REPLACEMENT	17
Replacing Batteries	17
When to Replace Batteries	17
How to Replace Batteries	18
Testing New Batteries	19
Returning the Used Battery	20
UPS/Battery Care and Storage	20
Storing the UPS	20
UPS Repairs	20

SECTION 5	
TROUBLESHOOTING.....	21
APPENDIX A	
ADDITIONAL UPS FEATURES	23
Communication Port Configurations	23
Option Slot	25
Load Segments.....	25
Remote Emergency Power Off (REPO)	25
APPENDIX B	
SPECIFICATIONS.....	27
APPENDIX C	
UPS REAR PANELS.....	30

List of Figures

Figure 1.	ACE Series Rack-Mount.....	2
Figure 2.	Attaching the Mounting Bracket.....	5
Figure 3.	Typical UPS Installation.....	7
Figure 4.	Interpreting LEDs in Operation Mode.....	10
Figure 5.	LED Function in Configuration Mode.....	15
Figure 6.	Replacing Batteries.....	19
Figure 7.	Communication Port.....	24
Figure 8.	REPO Port.....	26
Figure 9.	1000 and 1500 VA, 120 V, Rear Panel.....	30
Figure 10.	2000 VA, 120 V, Rear Panel.....	30
Figure 11.	3000 VA, 120 V, Rear Panel.....	31
Figure 12.	1000 and 1500 VA, 230 V, Rear Panel.....	31
Figure 13.	2000 and 2400 VA, 230 V, Rear Panel.....	32
Figure 14.	3000 VA, 230 V, Rear Panel.....	32

List of Tables

Table 1.	Interpreting LEDs in Operation Mode.....	11
Table 2.	How to Interpret LEDs in Configuration Mode.....	16
Table 3.	Troubleshooting Guide.....	21
Table 4.	Communication Port Configuration.....	24
Table 5.	Model List.....	27
Table 6.	Electrical Input.....	28
Table 7.	Electrical Output.....	28
Table 8.	Battery.....	28
Table 9.	Weights and Dimensions.....	29
Table 10.	Environmental and Safety.....	29
Table 11.	Indicators and Controls.....	29



P R E F A C E

ACE SERIES RACK-MOUNT — ONE OF THE BEST!

Congratulations on selecting the ACE Series Rack-Mount uninterruptible power system (UPS) to protect your sensitive electronic equipment from power disturbances and dirty power.

Because a power outage can occur when you least expect it — threatening the loss of critical data — it's important to protect your network with a full-featured UPS such as the ACE Series Rack-Mount. Network administrators often spend countless hours trying to troubleshoot problems that, in many cases, would never have occurred had a UPS protected their network.

Properly installed, a UPS can be the single most cost-effective measure you can take to ensure system security. Providing outstanding performance and reliability, the ACE Series Rack-Mount's unique benefits include the following:

- **Advanced Battery Management (ABM™)** doubles battery service life, optimizes recharge time, and provides a warning up to 60 days before the end of useful battery life.
- **Hot-swappable batteries** simplify maintenance by allowing you to safely replace batteries without powering down your critical load.
- **Network and modem protection** (may not be available on your model) guards your modem, fax machine, and other network communications equipment from surges.
- **Buck and Double Boost** regulation ensures consistent voltage to your load by correcting voltage fluctuations without using battery power.
- **Start-on-battery compatibility** allows you to power up your UPS even if utility power is not available.
- **Our power management software** is fully compatible with the ACE Series Rack-Mount and provides sequential orderly shutdown of all network devices including multiple servers and workstations.
- **Optional power communication cards** provide enhanced communication capabilities for increased power protection and longer battery backup times.



- **Compact design** conserves valuable space and makes the UPS easy to install.

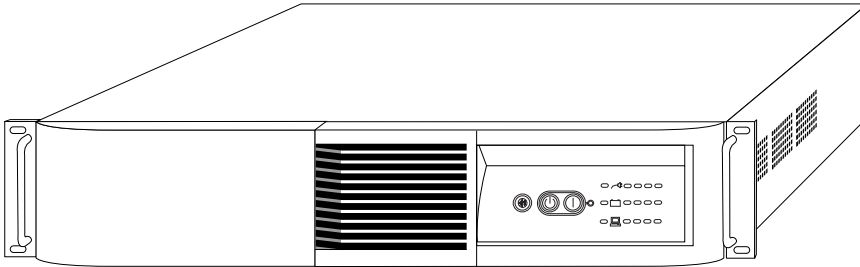

ACE1000a-RM, ACE1500a-RM, ACE1000i-RM, and ACE1500i-RM

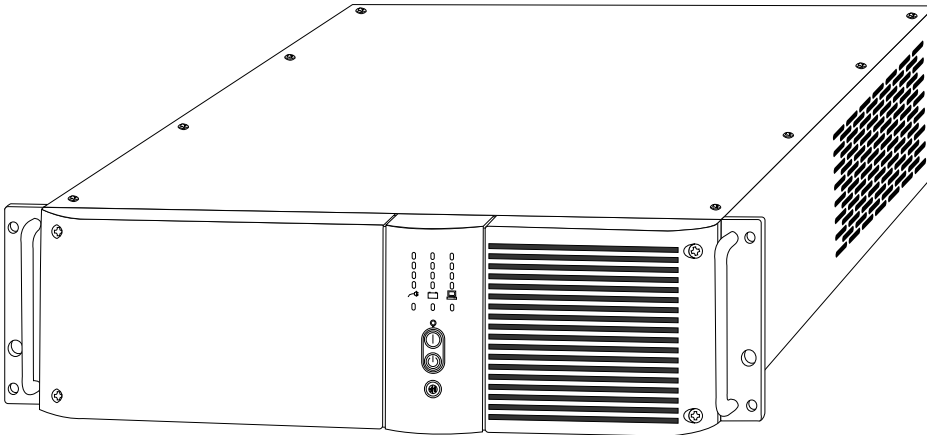

ACE2000a-RM, ACE3000a-RM, ACE2000i-RM, ACE2400i-RM, and ACE3000i-RM

Figure 1. ACE Series Rack-Mount

How to Contact Us

PowerVar is committed to excellence in dependability and customer satisfaction. If you have any questions about our products, please contact us at: 847-816-8585 (fax: 847-816-8988).



S E C T I O N 1

INSTALLATION

This section explains:

- Inspecting equipment
- Safety precautions
- Installing your UPS

Inspecting Your Equipment

If any equipment has been damaged during shipment, keep the shipping cartons and packing materials for the carrier or place of purchase and file a claim for shipping damage. If you discover damage after acceptance, file a claim for concealed damage.

To file a claim for shipping damage or concealed damage: 1) File with the carrier within 15 days of receipt of the equipment; 2) Send a copy of the damage claim within 15 days to your service representative.

Safety Precautions

Read the following before you install your UPS.

IMPORTANT SAFETY INSTRUCTIONS

SAVE THESE INSTRUCTIONS. This manual contains important instructions that you should follow during installation and maintenance of the UPS and batteries. Please read all instructions before operating the equipment and save this manual for future reference.



WARNING

- Electrical Energy Hazard. The battery pack contains HIGH ENERGY. To reduce the risk of electric shock, use caution when you handle and interconnect the units.
- If operating the UPS while it is unplugged from the source of electrical power, DO NOT make contact with the line cord input pins. Electrical shock hazard exists.
- To reduce the risk of fire or electric shock, install in a temperature- and humidity-controlled indoor area free of conductive contaminants.
- (VDE requirement) The sum of earth leakage current from all loads connected to the UPS must not exceed 1.5 mA.

Mounting the UPS in a Rack

The UPS fits in a 19-inch rack. Follow the steps below to install the UPS in the rack.



WARNING

The UPS is heavy. It can be very awkward, and potentially dangerous, to handle. Therefore, it is mandatory that a minimum of two people lift and place the UPS in its rack.

NOTE

Disconnect all cables from the UPS before continuing. Remove all self-adhesive pads from the underside of the unit, if already fitted.

1. Place the unit on a hard, flat surface with the front of the unit facing toward you.
2. If the mounting brackets are not already installed, position a mounting bracket over the mounting holes on one side of the unit, as shown in Figure 2.
3. Insert the screws and fully tighten using a suitable screwdriver.
4. Repeat steps 2 and 3 for the other side of the unit.
5. Using at least two people, lift the unit and slide it into the rack.
6. Secure the UPS by screwing the mounting angles to the rack face (screws not provided). The unit is now secured in the rack.

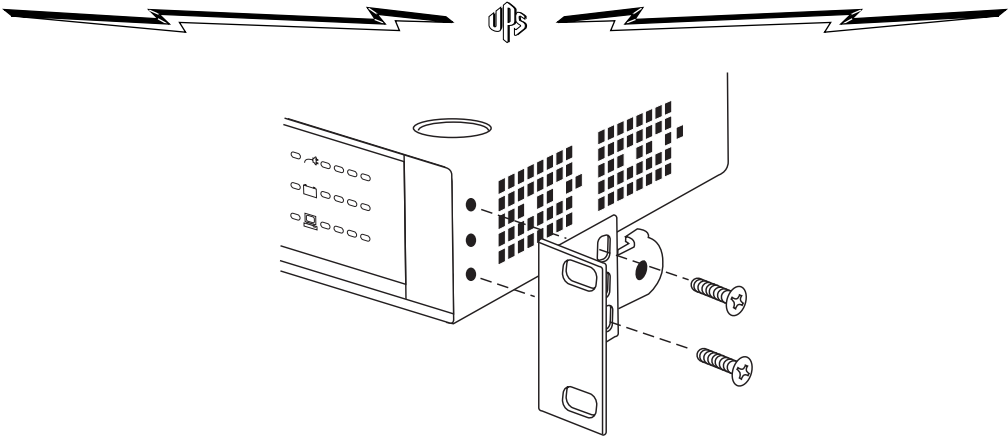

Figure 2. Attaching the Mounting Bracket

Installing the UPS

Follow these steps to install your UPS. Figure 3 shows a typical installation; installing your specific model may vary. Appendix C shows the rear panel of each model.

NOTE

Some units may not recognize 50 Hz outlets. If you connect your UPS to a 50 Hz outlet, and it will not start, press the ON button for 3 seconds to start the UPS on battery. Then configure the UPS input voltage for either 100 V or 110 V (see Section 3, Configuration). The UPS recognizes the input line and goes off battery.



CAUTION

DO NOT plug laser printers into a UPS. The high surge currents they produce can disrupt any manufacturer's UPS.

NOTE

- If your UPS output receptacles are divided into Load Segments, and you plan to take advantage of this feature (available only with specific power management software), read the appropriate sections of your power management software manual before you install the UPS.
- Changes or modifications not expressly approved by the party responsible for compliance could void your authority to operate the equipment.



1. If you plan to use our power management software, connect your computer's communication cable to the UPS RS-232 port.
2. Plug your UPS power cord into a wall outlet or other power source.

If your UPS uses a customer-supplied power cord, it must be correctly rated (see Appendix B, Specifications). You can also use the power cord from your largest load if it is correctly rated.

Once the UPS is connected, it conducts a self-test and then goes to Standby mode. If a red Site Wiring or Battery Service LED stays on, consult Section 2, Operation, or Section 5, Troubleshooting.

3. Plug your loads (computer, monitor, etc.) into the UPS output receptacles. Use the provided interconnecting line cords where applicable.
4. Start the UPS by pressing the ON button as shown in Figure 3. Power is now available to the rear receptacles, and the ON LED is lit.
5. You have now completed installation. To learn how to operate the UPS, see Section 2, Operation. To change the factory-set defaults, see Section 3, Configuration.

NOTE

The UPS will charge to 90% in approximately 4 hours. However, it is recommended that you charge for 24 hours after installation or long storage.

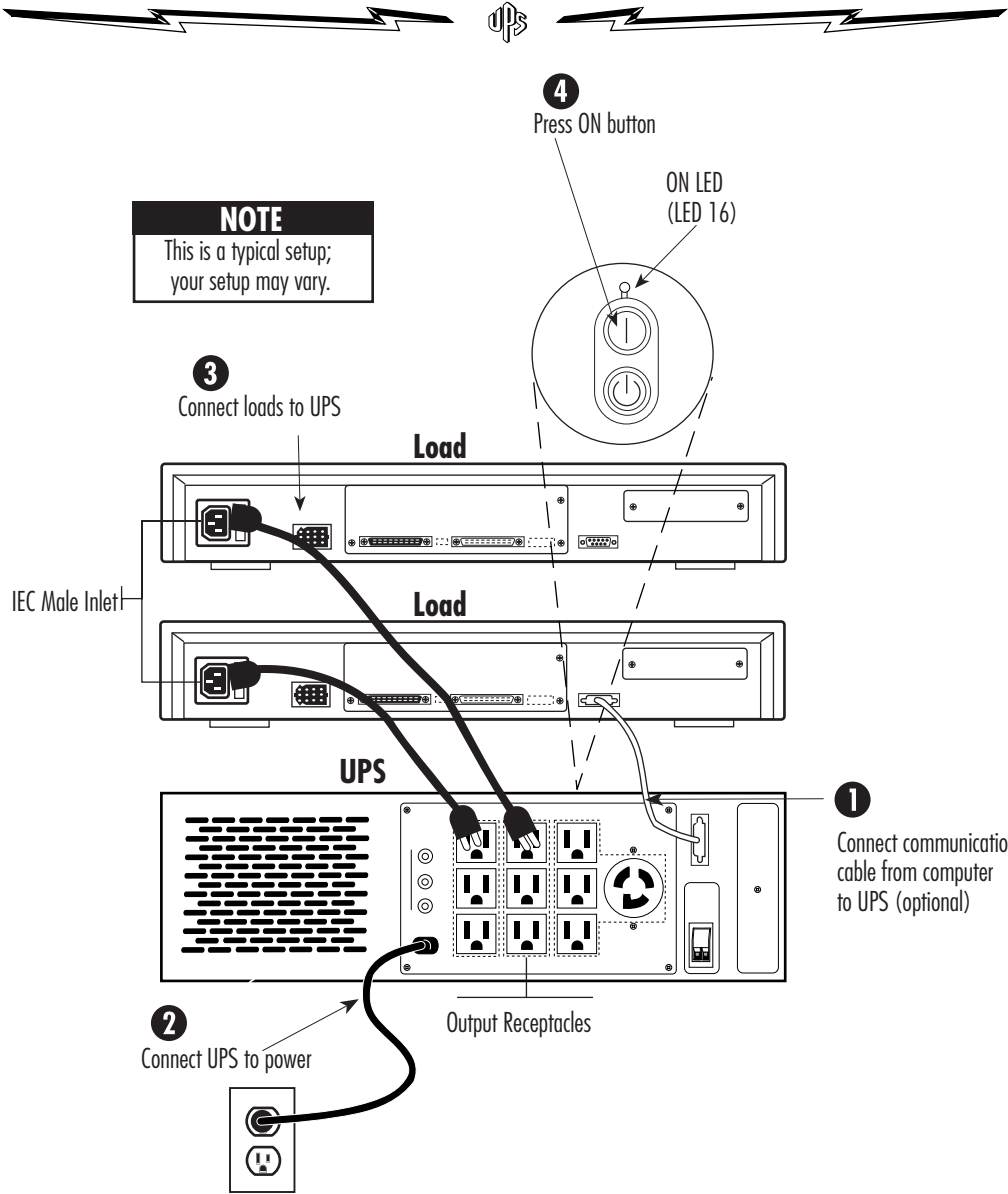

Figure 3. Typical UPS Installation (low voltage model shown)



S E C T I O N 2

OPERATION

This section explains how to:

- Turn the UPS on and off
- Interpret the LED display
- Put the UPS in Standby mode
- Initiate the self-test
- Silence an audible alarm

Turning the UPS On

Once the UPS is connected to a power source, it conducts a self-test and enters Standby mode. To turn the UPS on, press the ON button on the front panel (shown in Figure 4). Power is now available at the rear receptacles.

To turn the UPS on without using AC input, press the ON button for 3 seconds. When the UPS starts on battery, it conserves battery power by not conducting a self-test.

Turning the UPS Off

To turn the UPS off, press the OFF/Standby button on the front panel and unplug the UPS from the AC power source. If you do not unplug the UPS, it remains in Standby mode.

Silencing an Audible Alarm

Press the Test/Alarm Reset button to silence an audible alarm.

Although you have silenced the alarm, you may still need to resolve the problem which triggered the alarm. For more information, see Section 5, Troubleshooting.



Interpreting the LED Display

The front panel LEDs indicate how the UPS is functioning and also warn about possible problems. Figure 4 and Table 1 explain how to interpret the LEDs when the UPS is in Operation mode. When the UPS is in Configuration mode, the front panel LEDs provide different information. For more information about how to interpret LEDs when the UPS is in Configuration mode, see Section 3, Configuration.

NOTE

The front panel may be rotated clockwise 90 degrees on some models.

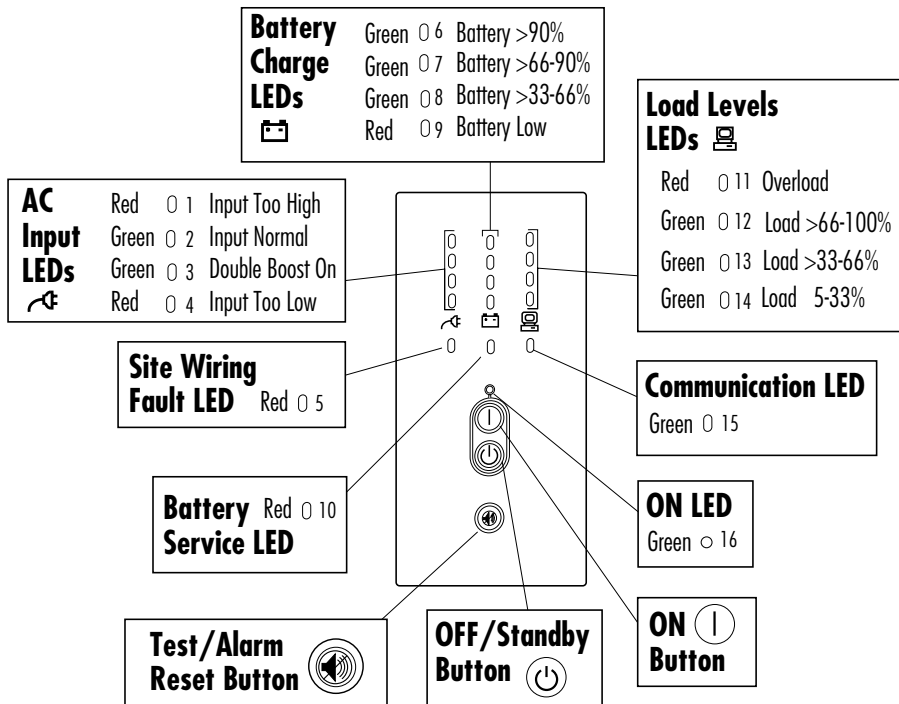

Figure 4. Interpreting LEDs in Operation Mode



Table 1. Interpreting LEDs in Operation Mode

Name	Number	Color	Explanation (if lit)
ON	16	Green	Output voltage available at the rear outlets.
AC Input	1	Red	Line voltage is too high; UPS battery provides all power.
	2	Green	Line voltage is normal; AC input provides all power.
	3	Green	Line voltage is lower than normal; AC input provides all power.
	4	Red	Line voltage is too low; UPS battery provides all power.
Site Wiring Fault	5	Red	Ground wire connection doesn't exist, or the line and neutral wires are reversed in the socket.
Battery Charge	6	Green	Batteries are fully charged.
	7	Green	Battery charge is approximately 2/3 of full charge.
	8	Green	Battery charge is approximately 1/3 of full charge.
	9	Red	Low battery charge; there are approximately 3-5 minutes of battery backup remaining. If the battery shuts down before AC input is restored, the load also shuts down.
Battery Service	10	Red	Potential battery failure.
Load Level	11	Red	Load current exceeds full load.
	12, 13, 14	Green	The amount of load current or watts. Each LED represents 1/3 of a full load rating. When all three LEDs are green, the load is approximately full.
Communication	15	Green	The UPS has received a command from a computer to establish communication.
		(Flashing)	Data is being transferred via the Communication Port.

Putting the UPS in Standby Mode

To put the UPS in Standby mode, press the OFF/Standby button. In Standby mode, the battery recharges when necessary, but power is no longer available at the rear receptacles.

Initiating the Self-Test

Press the Test/Alarm Reset Button for three seconds to initiate the self-test. During the test, individual LEDs turn on as various parts of the UPS are checked. If the UPS finds a problem, an LED turns on to indicate where the problem is. For more information, see Section 5, Troubleshooting.

NOTE

Batteries must be at least 90% charged (LEDs 6, 7, and 8 must be on) and the unit must be off battery, to perform the self-test.



S E C T I O N 3

CONFIGURATION

This section explains:

- Why you may want to change factory defaults
- How to reconfigure functions

Why Change Factory Defaults?

Input Nominal Voltage (LEDs 1, 2, 3, and 10)

If your AC input consistently fluctuates higher OR lower than the factory-set nominal input voltage (higher than +20% OR lower than -30% of 120 V or 230 V nominal), your UPS maintains the selected nominal input voltage by repeatedly switching to battery power. If this creates a nuisance, you can configure the UPS nominal input voltage to more closely match the nominal voltage of your AC input source.

Extended Nominal Voltage Range (LED 4)

If your AC input consistently fluctuates higher AND lower than the factory-set nominal input voltage (higher than +20% AND lower than -30% of 120 V or 230 V nominal), your UPS maintains the selected nominal input voltage by repeatedly switching to battery power. If this creates a nuisance, you can configure the UPS nominal input voltage to more closely match the wider range of your AC input source.

Other Settings

Reconfigure LEDs 5, 6, or 8 to change the alarms. Reconfigure LED 7 to change the delay before unconditional shutdown. Reconfigure LED 9 so the UPS does not shut off power to the load when the UPS is on battery power and the load is not drawing current. LEDs 11 through 14 are inactive and cannot be selected.



Reconfiguring Functions

You can change the functions after switching the UPS from Operation mode to Configuration mode. In Configuration mode the front-panel LEDs represent changeable functions, and the control buttons turn them on or off. Figure 5 shows the LED numbers, and Table 2 explains the functions.



CAUTION

DO NOT press the UPS OFF button, while the UPS is in Configuration mode. The UPS will switch to Standby and cut off all power to the attached loads.

1. Press the ON and Test/Alarm Reset buttons at the same time for one beep. The unit goes to Configuration mode.
2. Press the ON button to scroll to the function you want to change. The UPS beeps as you scroll through each function. The selected function (LED) blinks. Figure 5 shows how the LEDs are numbered. Table 2 describes the functions.
3. If you press the ON button and nothing happens, you are still in Operation mode. Repeat step 1 for one beep ONLY to go to Configuration mode, and then perform step 2.
4. Press the Test/Alarm Reset button ONCE to turn the selected function on or off. LED 16 turns on when the function is on and off when the function is off. Set the remaining functions as desired.
5. Press the ON and Test/Alarm Reset buttons any time to return to Operation mode. Scrolling through LED 15 also returns the unit to Operation mode. Changes take effect immediately after returning to Operation mode.

NOTE

The front panel may be rotated clockwise 90 degrees on some models.

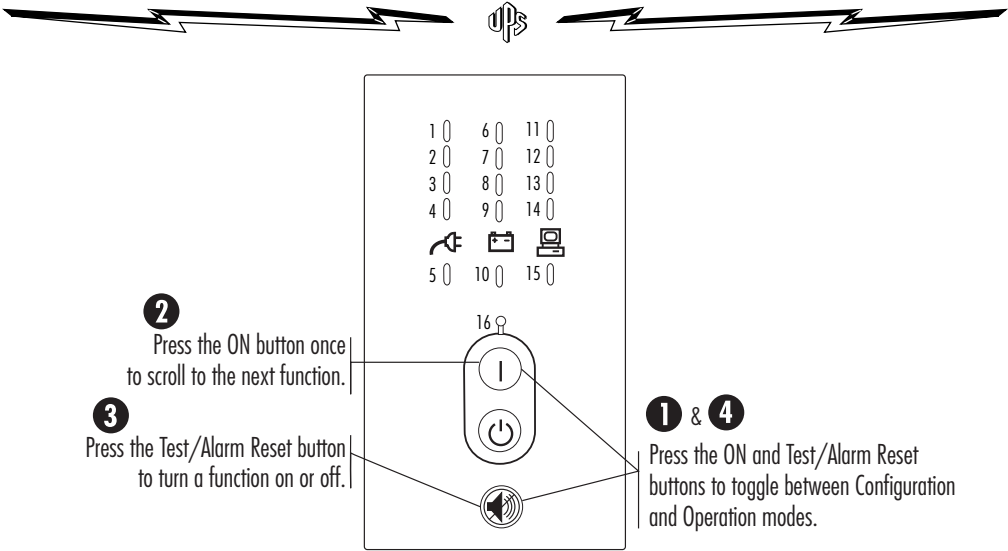

Figure 5. LED Function in Configuration Mode

NOTE

The factory default nominal voltage for some models may be set for 100 or 208 VAC. (See the rating label on the UPS rear panel). If this is the case, the default LEDs in Configuration mode are as follows: For low voltage models, LED 1 is OFF and LED 10 is ON. For high voltage models, LED 1 is OFF, LED 5 is OFF, and LED 10 is on.



Table 2. How to Interpret LEDs in Configuration Mode

LED	Function	LED 16	Explanation
1	120/230 Nom.	ON (default)	Nominal voltage on low voltage models is 120 V and on high voltage models is 230 V; all other nominal input voltages are disabled.
		OFF	Nominal voltage on low voltage models is NOT 120 V and on high voltage models is NOT 230 V; some other nominal input voltage is selected.
2	110/220 Nom.	ON	Nominal voltage on low voltage models is 110 V and on high voltage models is 220 V; all other nominal input voltages are disabled.
		OFF (default)	Nominal voltage on low voltage models is NOT 110 V and on high voltage models is NOT 220 V; some other nominal input voltage is selected.
3	127/240 Nom.	ON	Nominal voltage on low voltage models is 127 V and on high voltage models is 240 V; all other nominal input voltages are disabled.
		OFF (default)	Nominal voltage on low voltage models is NOT 127 V and on high voltage models is NOT 240 V; some other nominal input voltage is selected.
4	Extended Voltage	ON	The UPS accepts an input voltage within -35% to +20% of the selected nominal input voltage before switching to battery.
		OFF (default)	The UPS accepts an input voltage within -30% to +20% of the selected nominal input voltage before switching to battery.
5	Wiring Fault Alarm	ON (default)	Alarm sounds when the polarity of the input source is reversed or ground is missing; have a qualified electrician repair input source.
		OFF	Alarm DOES NOT sound when the polarity of the input source is reversed or ground is missing.
6	Low Battery Alarm	ON (default)	Alarm sounds 3 minutes before battery shutdown.
		OFF	Alarm sounds 5 minutes before battery shutdown.
7	Shutdown Delay	ON (default)	5-second delay before unconditional shutdown after UPS receives signal from a computer via Communication Port.
		OFF	180-second delay before unconditional shutdown after UPS receives signal from a computer via Communication Port. When this LED is not enabled, the user can also create a new delay time by reconfiguring the Communication Port. See Appendix A, Additional UPS Features, for more information.
8	AC Input Failure	ON (default)	Alarm sounds when there is an AC input failure.
		OFF	Alarm DOES NOT sound when there is an AC input failure.
9	Sleep Mode	ON (default)	UPS shuts off power to load when the UPS is on battery power and load is not drawing current. This feature saves battery power.
		OFF	UPS DOES NOT shut off power to load when the UPS is on battery power and load is not drawing current.
10	100/208 Nom.	ON	If your unit is configurable for 100 V operation, when LEDs 10 and 16 are both on, the nominal voltage on 100 V models is 100 V and on 208 V models is 208 V; all other nominal input voltages are disabled.
		OFF (default)	Nominal voltage on 100 V models is NOT 100 V and on 208 V models is NOT 208 V; some other nominal input voltage is selected.
11-14		N/A	Reserved for future use.
15	Reset Defaults	ON (default)	All factory-set defaults are active.
		OFF	One or more factory-set defaults have been changed.



S E C T I O N 4

UPS CARE AND BATTERY REPLACEMENT

This section explains how to:

- Replace your batteries
- Return your used batteries
- Care for your UPS and batteries
- Store your UPS

Replacing Batteries

Our hot-swappable battery feature allows you to replace your UPS batteries easily without turning the UPS off or disconnecting the load. The following section explains how.

When to Replace Batteries

When the Battery Service LED (LED 10) turns red, your batteries may need replacing. Conduct a self-test by pressing the Test/Alarm Reset button. If the LED stays on, contact your service representative to order new batteries.



WARNING

- **ELECTRIC ENERGY HAZARD.** Do not attempt to alter wiring in either the battery connector or the battery tray. Attempting to alter wiring can cause injury or death.
 - A battery can present a risk of high short circuit current which can cause burns. The following precautions should be observed when working on batteries: 1) Remove watches, rings, or other metal objects; 2) Use tools with insulated handles; 3) Do not lay tools or metal parts on top of batteries.
 - The battery has no support when you pull it out of the UPS. Pull the battery out onto a flat, stable surface.
-



CAUTION



- When the UPS is on line, all three green Battery Charge LEDs (6, 7, 8) should be lit before replacing (hot-swapping) the batteries. DO NOT DISCONNECT the batteries while the UPS is on battery power or while the UPS is charging the batteries.
- If you choose to unplug the UPS to change the battery: 1) Press the OFF button and remove input power; 2) Wait 60 seconds while the internal microprocessor shuts down before you disconnect the battery.

CAUTION



The UPS and its batteries are heavy. If your unit is installed in a rack, you must support the front of the unit while replacing the batteries.

How to Replace Batteries

Figure 6 shows how to replace your UPS batteries. Consider all warnings, cautions, and notes before replacing batteries.

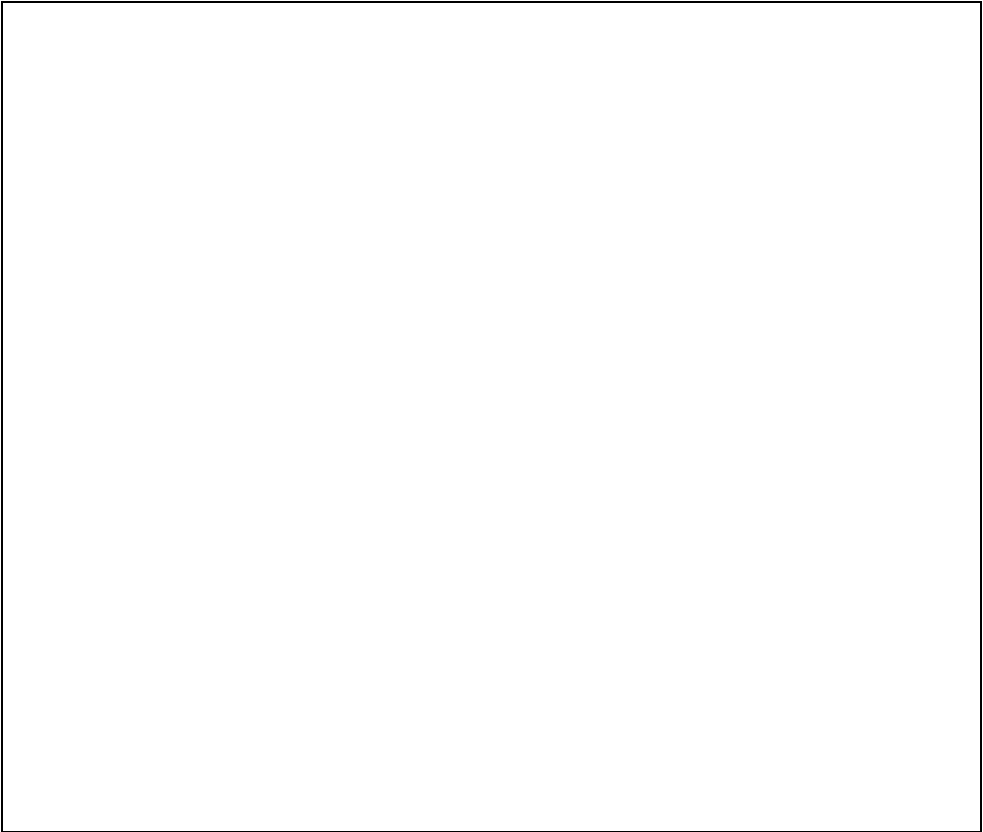

Figure 6. Replacing Batteries

Testing New Batteries

Press the Test/Alarm Reset button to start a self-test. The red Battery Service LED (LED 10) should turn off and the Battery Charge LEDs (LEDs 6, 7, and 8) should show a charge. If the red Battery Service LED stays on, check the battery connections. If it remains on, see Section 5, Troubleshooting, or call your service representative.



Returning the Used Battery

Use the packaging from your new battery to return your old battery. Call your service representative to get information about returning your used battery.



WARNING

- Do not dispose of battery or batteries in a fire. Batteries may explode. Dead batteries are considered a hazardous waste. Return batteries to the factory for proper disposal. It is illegal to dump or improperly dispose of batteries.
- Do not open or mutilate the battery or batteries. Released electrolyte is harmful to the skin and eyes. It may be toxic.



CAUTION

This product contains sealed, lead-acid batteries which must be recycled. For more information, contact your local recycling center or your service representative.

UPS/Battery Care and Storage

For the best preventive maintenance, keep the area around the UPS clean and dust-free. If the atmosphere is very dusty, clean the outside of the system with a vacuum cleaner.

For full battery life, keep the UPS at an ambient temperature of 25°C (77°F).

Storing the UPS

If you store the UPS for a long period, recharge the battery every six months by plugging the UPS into a power outlet. The UPS will charge in Standby mode. Charging takes 6 to 24 hours.

UPS Repairs

Repairs on your UPS must be performed by the factory or by factory-authorized service locations. If you have any questions or problems, please contact your service representative.



SECTION 5

TROUBLESHOOTING

This section explains:

- How to recognize the symptoms of UPS problems
- The possible causes of UPS problems
- How to correct UPS problems.

Table 3. Troubleshooting Guide

Symptom	Possible Cause	What To Do
LED 16 is not on; the UPS will not start.	A circuit breaker or an input fuse on the rear panel is open.	Push the circuit breaker button or replace the fuse (see Appendix C, UPS Rear Panels).
	The line cord is not connected.	Connect the line cord.
	The wall outlet is dead.	Have a qualified electrician test and repair the outlet.
	The UPS may be unable to recognize a 100 V, 50 Hz wall outlet.	See Appendix B, Specifications, to verify that your UPS accepts 100 V nominal input. Unplug the UPS. Start the UPS on battery and reconfigure the nominal input voltage for 100 V (see Section 3, Configuration). Turn the UPS off for 3 seconds. Plug the UPS into an outlet.
	A battery fuse or circuit breaker is open.	Contact your service representative.
The UPS switches frequently between battery and AC input.	Input voltage in your area differs from the UPS nominal.	Change the UPS nominal input to match your local nominal; see Section 3, Configuration.
The Low Battery Alarm does not give enough warning.	The batteries need charging or service.	Plug the UPS into a wall outlet for 24 hours, to charge the battery; press the Test/Alarm Reset button for three seconds; then check LED 10 (Battery Service).
	The Low Battery Alarm is not set appropriately.	Change the alarm setting. See Section 3, Configuration.
LED 1 (AC Input, High) or LED 4 (AC Input, Low) are on.	The line voltage is too high or too low; the UPS is running on battery power.	Correct the input voltage, if possible, or be prepared for a power failure less than 5 minutes after LED 9 turns on (depending on configuration, with normal load and ample charge). If LED 1 or LED 4 are on continuously, the input voltage in your area may differ from the UPS nominal. Change your UPS to match your local conditions. See Section 3, Configuration, for more information.

continued



Table 3. Troubleshooting Guide (continued)

Symptom	Possible Cause	What To Do
LED 5 (Site Wiring Fault) is on.	There is no ground wire or ground connection in the wall outlet.	Have a qualified electrician establish a grounding connection.
	The line and neutral wires are reversed in the wall outlet.	Have a qualified electrician correct the wiring.
		To disable this fault condition, see Section 3, Configuration.
LED 9 (Battery Charge, Low) is on.	The battery is running low.	Less than 5 minutes of power remains (depending on configuration, with normal load and ample charge); prepare for a power failure. Save your work and turn off your equipment.
LED 10 (Battery Service) is on, or on only during startup.	The battery may be fully discharged because of a long storage period or failing because of age.	Plug the UPS into a wall outlet for 24 hours to charge the battery. Push the Test/Alarm Reset button, then check LED 10. If LED 10 is still on, see Section 4, UPS Care and Battery Replacement, to replace the battery.
	The battery is not connected correctly.	Check connections or call your service representative.
LED 10 (Battery Service) is flashing.	The DC voltage is high; the alarm won't clear	Contact your service representative.
LED 11 (Load Level, Overload) is on.	The load is drawing too much power from the UPS.	Determine if the load is defective or if some of the load needs to be disconnected.



A P P E N D I X A

ADDITIONAL UPS FEATURES

This appendix explains:

- How to use the UPS Communications capabilities
- Where to find more information about Option Cards
- Where to find more information about Load Segments (may not be available on all units)
- How to install the Remote Emergency Power Off

Communication Port Configurations

To establish communication between the UPS and a computer, plug the UPS/Computer Interface Cable into the Comm Port. Use only the factory-supplied cable and software. The UPS operates normally if you do not use this port.



CAUTION

To prevent damage to your equipment, connect only a factory-supplied cable or a cable built to factory specifications (see Table 4) to your RS-232 port. A standard serial cable may damage your computer.

As shown in Table 4, the communication port Pins 1 and 2 operate in two modes. The first is Basic Alarms mode, which has AC fail alarm and output shutdown. The second is Serial Data mode, which is UPS Code II compliant.

The system always starts in Basic Alarms mode. When serial data is received at Pin 1, the function of Pin 1 and Pin 2 changes to Serial Data mode.

If serial data has not been received before going to battery power, serial communications is disabled until AC input returns.



If the computer is running power management software, the interface cable between the UPS and the computer's Comm Port enables a data exchange. Every 30 seconds, the software polls the UPS for detailed information on the status of the power environment. If a power emergency occurs, the software initiates the saving of all data and an orderly shutdown of the equipment.

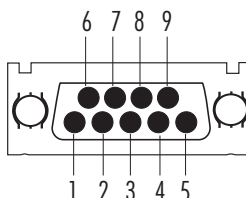

Figure 7. Communication Port

Table 4. Communication Port Configuration

Pin #	Signal Type	Function
1	Basic Alarms Mode — Input: RS-232 level low (+12 V) pulse 4 to 5 seconds	Remote UPS off: In absence of AC, output is turned off until normal AC returns
	Serial Data Mode — Input: RS-232 data	RS-232 serial communication input. 1200 baud, 8-bit, no parity, one stop bit, one start bit, Xon/Xoff
2	Basic Alarms Mode — Output: RS-232 level low (+12 V)	AC Input failure
	Serial Data Mode — Output: RS-232 data	RS-232 serial communication output. Same as input
3	Output: Open collector transistor ON, 50 mA, 40 VDC rating	AC Input failure
4	Signal Common	Signal Common
5	Output: Open collector transistor ON, 50 mA, 40 VDC rating	Impending low battery
6	Input: RS-232 RTS	Plug and Play software enable trigger (activates when pin changes from +12 V to -12 V)
7	Input: Relay contact or RS-232 level	Remote output OFF: UPS total output can be kept off with low signal or closing relay contact
8	Output: 8 to 25 VDC, 5 W constant power (0.63 A max. @ 8 V)	Auxiliary Control Power
9	Chassis	Connection to chassis



Option Slot

The option slot accepts various installable option modules that help your UPS communicate in a variety of networking environments. See the manual that accompanies each module for more information, or contact your sales representative.

Load Segments

Load Segments are sets of receptacles that can be turned on individually using our power management software. For example, during a power outage, you can keep key pieces of equipment running while you turn off other equipment. This feature allows you to save battery power. See your power management software manual for details.

Remote Emergency Power Off (REPO)

The UPS has a REPO connector that can be wired to a device that can be used to turn the UPS off from a remote location. The following instructions explain how to wire the REPO switch.



WARNING

Connect the REPO port to dry, isolated, normally-open contacts rated 60 VDC maximum, 30 VAC RMS maximum, 20 mA maximum. Failure to conform to these guidelines may create dangerous conditions for the operator by disabling the safety insulation of the equipment.

NOTE

Activation takes place upon closing.

1. Remove the REPO connector from the REPO port on the rear panel of the UPS.
2. Connect dry, isolated, normally-open contacts across the REPO device to PIN 1 and PIN 2. (Figure 8 shows the location of the pins on the UPS REPO connector.) Use stranded non-shielded wiring, size #22 through #18.
3. Reconnect the REPO connector to the UPS.

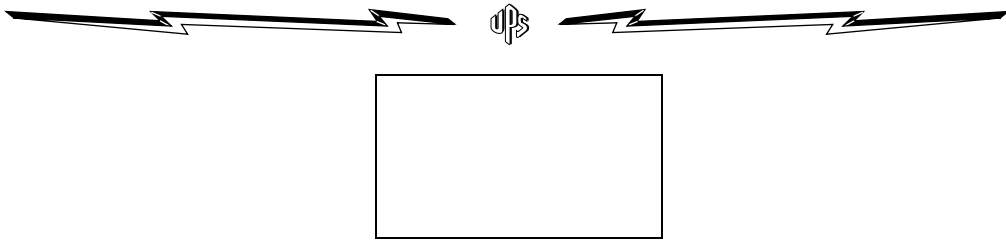

Figure 8. REPO Port



A P P E N D I X B

SPECIFICATIONS

For all of the models listed in Table 5, Model List, this appendix provides detailed specifications for the following:

- Electrical input and output
- Battery
- Weights and dimensions
- Environmental and safety

NOTE

ACE...a-RM and ACE...i-RM models are the same as PRC...a-RM and PRC...i-RM models.

Table 5. Model List

Feature	Specification		
UPS Models:	<table border="0"> <tr> <td style="vertical-align: top;"> <u>Low Voltage Models</u> ACE1000a-RM ACE1500a-RM ACE2000a-RM ACE3000a-RM </td> <td style="vertical-align: top;"> <u>High Voltage Models</u> ACE1000i-RM ACE1500i-RM ACE2000i-RM ACE2400i-RM ACE3000i-RM </td> </tr> </table>	<u>Low Voltage Models</u> ACE1000a-RM ACE1500a-RM ACE2000a-RM ACE3000a-RM	<u>High Voltage Models</u> ACE1000i-RM ACE1500i-RM ACE2000i-RM ACE2400i-RM ACE3000i-RM
<u>Low Voltage Models</u> ACE1000a-RM ACE1500a-RM ACE2000a-RM ACE3000a-RM	<u>High Voltage Models</u> ACE1000i-RM ACE1500i-RM ACE2000i-RM ACE2400i-RM ACE3000i-RM		
Battery Models:	N/A. See Table 8		



Table 6. Electrical Input

Feature	Specification				
Nominal Voltage:	<table border="0"> <tr> <td><u>Low Voltage Models</u></td> <td><u>High Voltage Models</u></td> </tr> <tr> <td>120 V default; 100, 110, 120, 127 V selectable</td> <td>230 V default; 208, 220, 230, 240 V selectable</td> </tr> </table>	<u>Low Voltage Models</u>	<u>High Voltage Models</u>	120 V default; 100, 110, 120, 127 V selectable	230 V default; 208, 220, 230, 240 V selectable
<u>Low Voltage Models</u>	<u>High Voltage Models</u>				
120 V default; 100, 110, 120, 127 V selectable	230 V default; 208, 220, 230, 240 V selectable				
Voltage Range:	-30% to +20% at full load for nominal voltage; -35% to +20% user selectable, extended range				
Nominal Frequency:	<table border="0"> <tr> <td><u>Low Voltage Models</u></td> <td><u>High Voltage Models</u></td> </tr> <tr> <td>60 Hz; 50/60 if 100 V or 110 V selected</td> <td>50/60 Hz</td> </tr> </table>	<u>Low Voltage Models</u>	<u>High Voltage Models</u>	60 Hz; 50/60 if 100 V or 110 V selected	50/60 Hz
<u>Low Voltage Models</u>	<u>High Voltage Models</u>				
60 Hz; 50/60 if 100 V or 110 V selected	50/60 Hz				
On-Line Efficiency:	96%				
Noise Filtering:	MOVs and line filter for normal and common mode noise				
Connections:	See Appendix C				

Table 7. Electrical Output

Feature	Specification												
Power Levels (rated at nominal inputs):	<table border="0"> <tr> <td><u>Low Voltage Models</u></td> <td><u>High Voltage Models</u></td> </tr> <tr> <td>ACE1000a-RM: 1000 VA, 670 W</td> <td>ACE1000i-RM: 1000 VA, 670 W</td> </tr> <tr> <td>ACE1500a-RM: 1440 VA, 960 W</td> <td>ACE1500i-RM: 1500 VA, 960 W</td> </tr> <tr> <td>ACE2000a-RM: 1920 VA, 1400 W</td> <td>ACE2000i-RM: 2000 VA, 1400 W</td> </tr> <tr> <td>ACE3000a-RM: 2880 VA, 2250 W</td> <td>ACE2400i-RM: 2300 VA, 1600 W</td> </tr> <tr> <td></td> <td>ACE3000i-RM: 3000 VA, 2250 W</td> </tr> </table>	<u>Low Voltage Models</u>	<u>High Voltage Models</u>	ACE1000a-RM: 1000 VA, 670 W	ACE1000i-RM: 1000 VA, 670 W	ACE1500a-RM: 1440 VA, 960 W	ACE1500i-RM: 1500 VA, 960 W	ACE2000a-RM: 1920 VA, 1400 W	ACE2000i-RM: 2000 VA, 1400 W	ACE3000a-RM: 2880 VA, 2250 W	ACE2400i-RM: 2300 VA, 1600 W		ACE3000i-RM: 3000 VA, 2250 W
<u>Low Voltage Models</u>	<u>High Voltage Models</u>												
ACE1000a-RM: 1000 VA, 670 W	ACE1000i-RM: 1000 VA, 670 W												
ACE1500a-RM: 1440 VA, 960 W	ACE1500i-RM: 1500 VA, 960 W												
ACE2000a-RM: 1920 VA, 1400 W	ACE2000i-RM: 2000 VA, 1400 W												
ACE3000a-RM: 2880 VA, 2250 W	ACE2400i-RM: 2300 VA, 1600 W												
	ACE3000i-RM: 3000 VA, 2250 W												
Regulation On-Line:	-10% to +6%; within Computer Business Equipment Manufacturers Association's guidelines; (-15% to +10% using extended range)												
Regulation On-Battery (Nominal Voltage \pm 5%):	<table border="0"> <tr> <td><u>Low Voltage Models</u></td> <td><u>High Voltage Models</u></td> </tr> <tr> <td>120 V for 110, 120, 127 V; 100 V for 100 V</td> <td>230 V for 220, 230, 240 V; 208 V for 208 V</td> </tr> </table>	<u>Low Voltage Models</u>	<u>High Voltage Models</u>	120 V for 110, 120, 127 V; 100 V for 100 V	230 V for 220, 230, 240 V; 208 V for 208 V								
<u>Low Voltage Models</u>	<u>High Voltage Models</u>												
120 V for 110, 120, 127 V; 100 V for 100 V	230 V for 220, 230, 240 V; 208 V for 208 V												
Voltage Wave Shape:	Sine Wave; <3% distortion with linear load												
Overcurrent Protection:	On-Line: Resettable Circuit Breaker; On-Battery: Active current limit and short circuit protection												
Connections:	See Appendix C												

Table 8. Battery

Feature	Specification
Configurations:	Internal batteries
Voltage:	24 VDC for ACE1000a-RM, ACE1500a-RM, ACE1000i-RM, and ACE1500i-RM 48 VDC for ACE2000a-RM, ACE3000a-RM, ACE2000i-RM, ACE2400i-RM, and ACE3000i-RM
Type:	Sealed, maintenance-free, valve-regulated, lead-acid
Charging:	Advanced charging for faster recovery; less than 3 hours to 90% usable capacity at nominal line and no supplementary power supply load
Monitoring:	Advanced monitoring for earlier failure detection and warning
Backup Time:	At least 5 minutes at full load with a new battery at approximately 25°C



Table 9. Weights and Dimensions

Feature	Specification												
UPS Dimensions (WxHxD):	ACE1000a-RM, ACE1500a-RM, ACE1000i-RM, ACE1500i-RM: 19.0 x 3.5 x 18.6 inches (48.2 x 8.9 x 47.2 cm) ACE2000a-RM, ACE3000a-RM, ACE2000i-RM, ACE2400i-RM, ACE3000i-RM: 19.0 x 5.3 x 22.3 inches (48.2 x 13.3 x 56.6 cm)												
UPS Weights:	<table border="0"> <tr> <td><u>Low Voltage Models</u></td> <td><u>High Voltage Models</u></td> </tr> <tr> <td>ACE1000a-RM: 58 lbs. (26 kg)</td> <td>ACE1000i-RM: 58 lbs. (26 kg)</td> </tr> <tr> <td>ACE1500a-RM: 58 lbs. (26 kg)</td> <td>ACE1500i-RM: 58 lbs. (26 kg)</td> </tr> <tr> <td>ACE2000a-RM: 132 lbs. (60 kg)</td> <td>ACE2000i-RM: 132 lbs. (60 kg)</td> </tr> <tr> <td>ACE3000a-RM: 132 lbs. (60 kg)</td> <td>ACE2400i-RM: 132 lbs. (60 kg)</td> </tr> <tr> <td></td> <td>ACE3000i-RM: 132 lbs. (60 kg)</td> </tr> </table>	<u>Low Voltage Models</u>	<u>High Voltage Models</u>	ACE1000a-RM: 58 lbs. (26 kg)	ACE1000i-RM: 58 lbs. (26 kg)	ACE1500a-RM: 58 lbs. (26 kg)	ACE1500i-RM: 58 lbs. (26 kg)	ACE2000a-RM: 132 lbs. (60 kg)	ACE2000i-RM: 132 lbs. (60 kg)	ACE3000a-RM: 132 lbs. (60 kg)	ACE2400i-RM: 132 lbs. (60 kg)		ACE3000i-RM: 132 lbs. (60 kg)
<u>Low Voltage Models</u>	<u>High Voltage Models</u>												
ACE1000a-RM: 58 lbs. (26 kg)	ACE1000i-RM: 58 lbs. (26 kg)												
ACE1500a-RM: 58 lbs. (26 kg)	ACE1500i-RM: 58 lbs. (26 kg)												
ACE2000a-RM: 132 lbs. (60 kg)	ACE2000i-RM: 132 lbs. (60 kg)												
ACE3000a-RM: 132 lbs. (60 kg)	ACE2400i-RM: 132 lbs. (60 kg)												
	ACE3000i-RM: 132 lbs. (60 kg)												

Table 10. Environmental and Safety

Feature	Specification				
Operating Temp:	0°C to 40°C (32°F to 104°F); UL tested 25°C (77°F)				
Storage Temp:	-20°C to 60°C (-4°F to 140°F)				
Relative Humidity:	5–95% non-condensing				
Operating Altitude:	Up to 3,000 meters above sea level				
Audible Noise:	Less than 45 dBA typical				
Surge Suppression:	IEEE C62.41 Category B				
Safety Conformance:	<table border="0"> <tr> <td><u>Low Voltage Models</u></td> <td><u>High Voltage Models</u></td> </tr> <tr> <td>UL 1778, CSA C22.2, No. 107.1</td> <td>EN 50091-1 and IEC 60950, UL 1778; CSA C22.2, No. 107.1</td> </tr> </table>	<u>Low Voltage Models</u>	<u>High Voltage Models</u>	UL 1778, CSA C22.2, No. 107.1	EN 50091-1 and IEC 60950, UL 1778; CSA C22.2, No. 107.1
<u>Low Voltage Models</u>	<u>High Voltage Models</u>				
UL 1778, CSA C22.2, No. 107.1	EN 50091-1 and IEC 60950, UL 1778; CSA C22.2, No. 107.1				
Safety Markings:	<table border="0"> <tr> <td><u>Low Voltage Models</u></td> <td><u>High Voltage Models</u></td> </tr> <tr> <td>UL, CSA</td> <td>CE, UL, and CSA</td> </tr> </table>	<u>Low Voltage Models</u>	<u>High Voltage Models</u>	UL, CSA	CE, UL, and CSA
<u>Low Voltage Models</u>	<u>High Voltage Models</u>				
UL, CSA	CE, UL, and CSA				
EMC:	<table border="0"> <tr> <td><u>Low Voltage Models</u></td> <td><u>High Voltage Models</u></td> </tr> <tr> <td>FCC, VCCI</td> <td>EN 55022, EN 50091-2</td> </tr> </table>	<u>Low Voltage Models</u>	<u>High Voltage Models</u>	FCC, VCCI	EN 55022, EN 50091-2
<u>Low Voltage Models</u>	<u>High Voltage Models</u>				
FCC, VCCI	EN 55022, EN 50091-2				

Table 11. Indicators and Controls

Feature	Specification
Serial Communication:	Intelligent serial communication to provide alarms with history, measured parameters, self-test, and many other features; contact your authorized dealer for UPS/computer communication software options
Interface:	Ergonomic Indicators: Wiring Fault, Battery Service, Communication, Operation, System Normal Bar Graphs: Input Level, Battery Charge Level, % Load
Contact Closures:	Input Failure, Low Battery



A P P E N D I X C

UPS REAR PANELS

This appendix shows the rear panels of all models discussed in this handbook, including (where applicable):

- Input and output receptacles, cords, and plugs
- Circuit breakers and fuses
- Comm ports

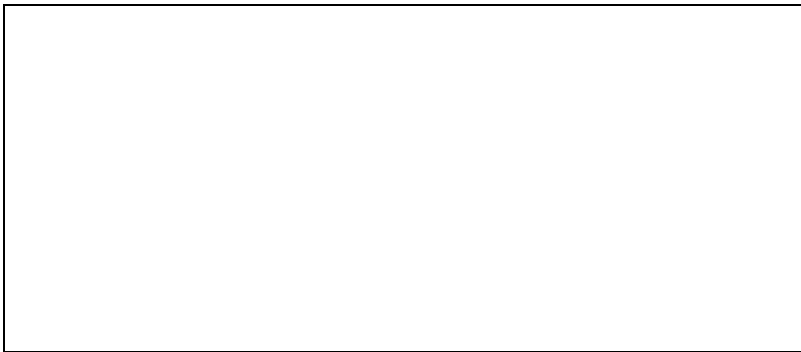

Figure 9. 1000 and 1500 VA, 120 V, Rear Panel

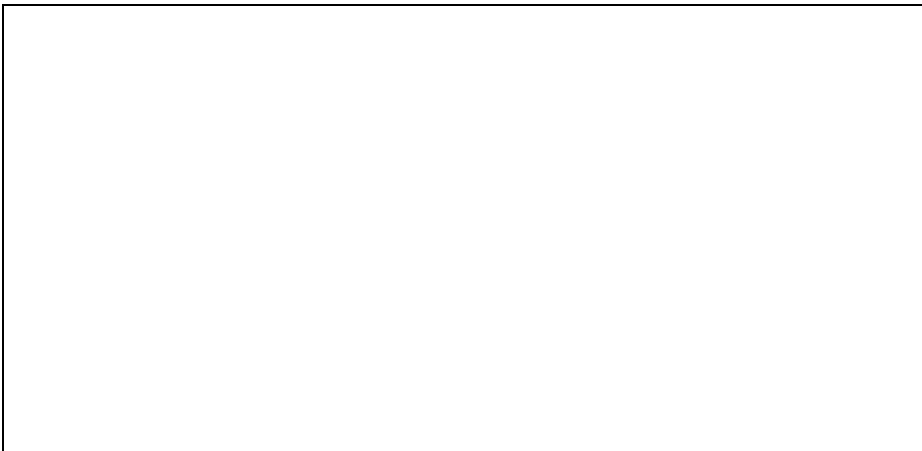

Figure 10. 2000 VA, 120 V, Rear Panel

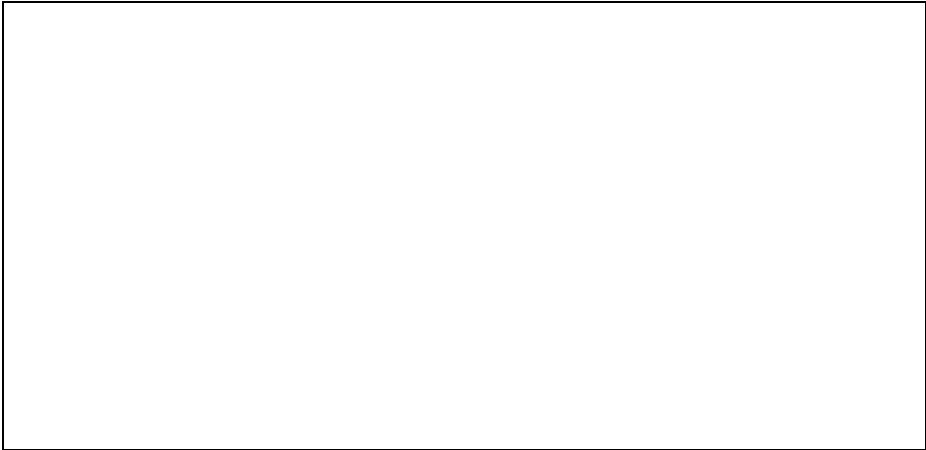

Figure 11. 3000 VA, 120 V, Rear Panel

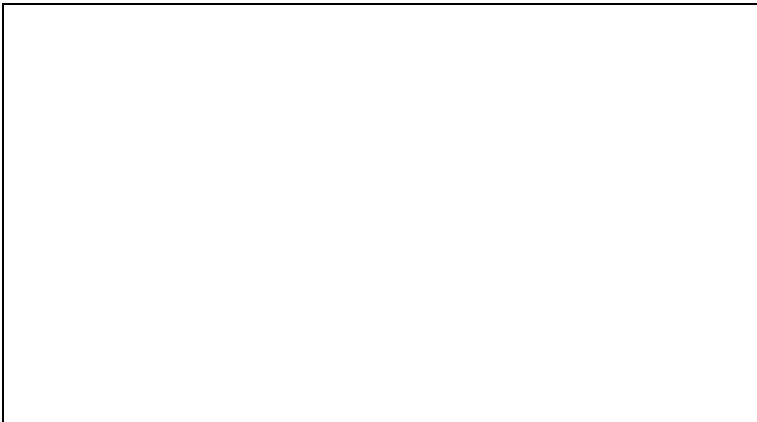

Figure 12. 1000 and 1500 VA, 230 V, Rear Panel

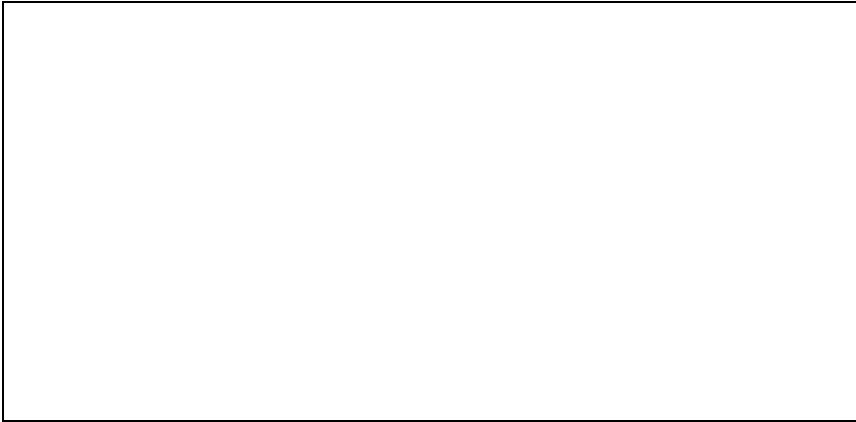

Figure 13. 2000 and 2400 VA, 230 V, Rear Panel

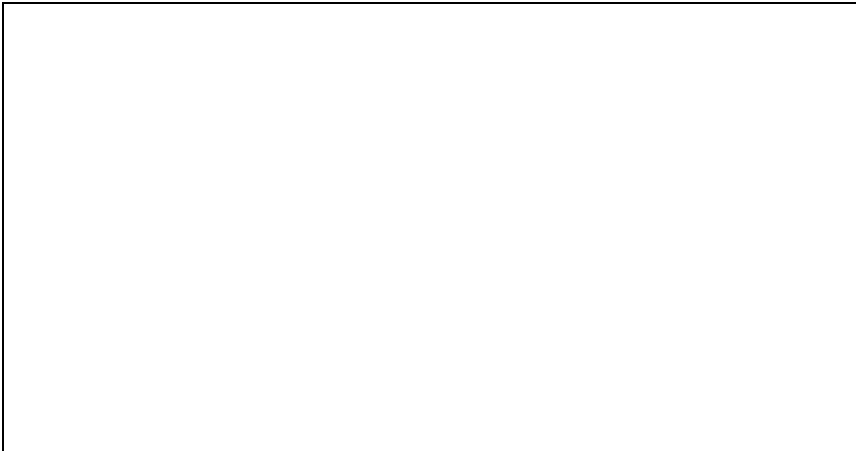

Figure 14. 3000 VA, 230 V, Rear Panel

PowerVar Standard Warranty

POWERVAR warrants its uninterruptible power supplies or UPS (known hereafter as the “product”) to be free from defects in materials or workmanship for a period of two years from the date of shipment. The product will be repaired or (at POWERVAR’s option) replaced at no charge during this warranty period. Product must be returned prepaid to the factory.

POWERVAR makes no warranties, expressed or implied, of merchantability, fitness for a particular purpose, performance, condition, capacity or otherwise. POWERVAR is not liable for incidental or consequential damages, monetary loss, loss of sales, or loss of business resulting from the failure or malfunction of the product. Warranty is void on any product that is misused, misapplied, abused, altered or repaired by any unauthorized personnel or there evidence of tampering exists. The foregoing constitutes the sole and exclusive remedy of the purchaser and is in lieu of all other Warranties. No greater degree of liability is imposed on POWERVAR.

05145651A